

MYSH

www.mysh.mx ventas@mysh.mx



WINDLASS



MANUFACTURER AND DISTRIBUTOR OF QUALITY OILFIELD EQUIPMENT

Creating Excellence



API 6A - 0896
API 16A - 0208
API 16C - 0093
API 16D - 0041



Certifications

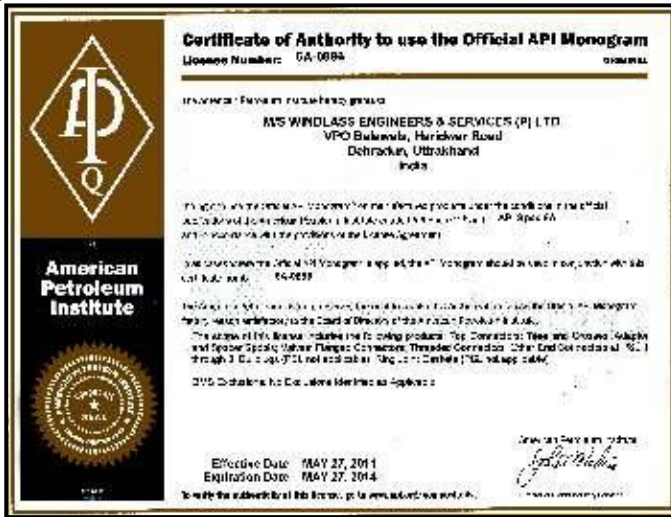

API 6A

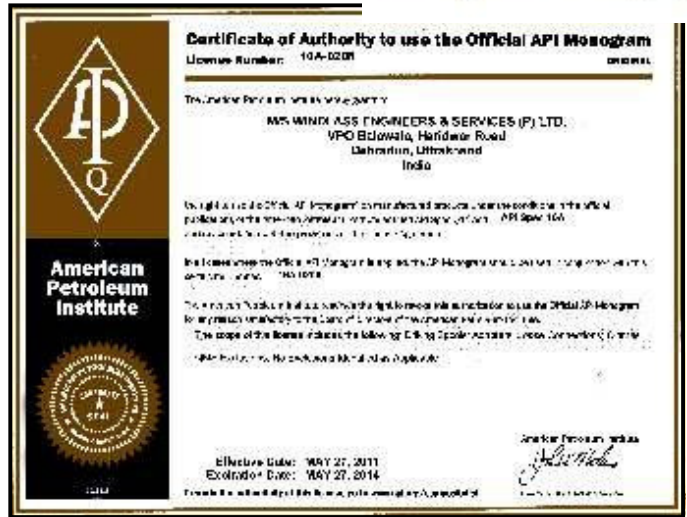

API 16A

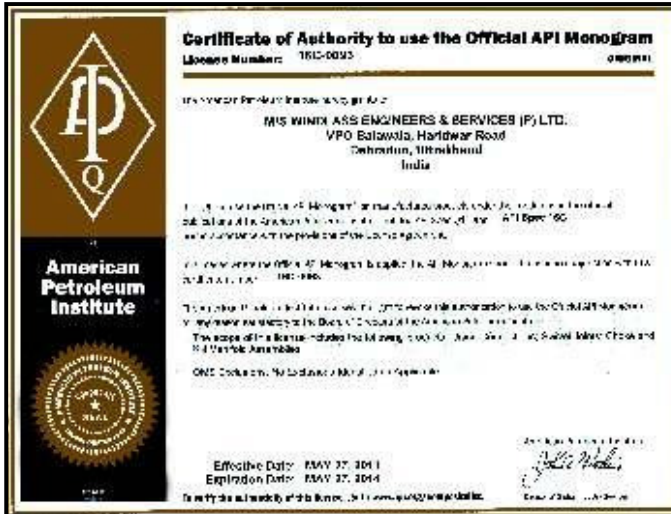

API 16C

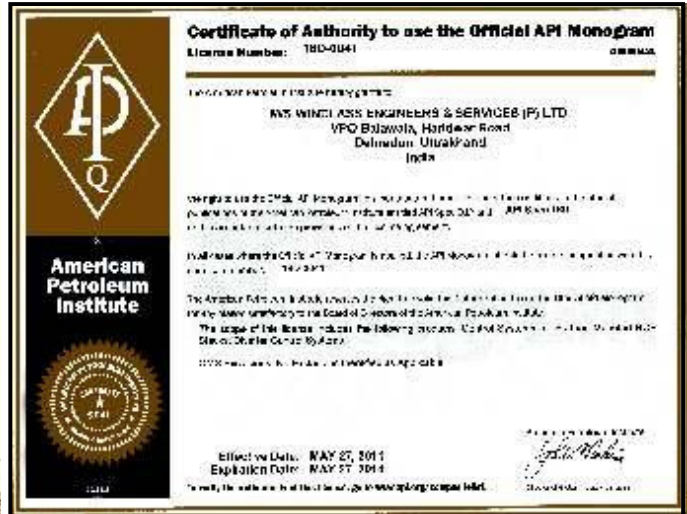

API 16D



CE/PED



ISO 9001-2008



Distribution Center, Houston, USA



Manufacturing Plant, Dehradun, India

Windlass Engineers & Services is an established manufacturer and distributor of quality oilfield equipment. Our manufacturing facility is spread over 10 acres with manufacturing buildings of 60,000 square feet that house state-of-the-art manufacturing processes manned by a highly qualified, motivated and experienced team.

Our product range includes:

- ◆ BOP Control Units
- ◆ Remote Control Panels
- ◆ Diverter Control Panels
- ◆ High Pressure Test Units
- ◆ Hydraulic Power Units
- ◆ Hammer Unions
- ◆ API Flanges, Tees & Crosses
- ◆ Choke & Kill and Cement & Stand Pipe Manifolds
- ◆ Swivel Joints
- ◆ Steel Hose Assemblies
- ◆ Pup Joints
- ◆ Adapters & Crossovers
- ◆ Spools-Drilling, Adapter & Spacer
- ◆ Integral Fittings - Elbows, Tees, Wyes
- ◆ Plug Valves
- ◆ Clamps & Hubs
- ◆ Hammer Seal Unions
- ◆ Hose Nipple Unions

Our products meet or exceed API 6A, 16A, 16C, 16D specifications. Our facility is ISO 9001-2008 certified by Det Norske Veritas (DNV).

Services offered:

- ◆ Repair, Refurbishment and Upgrade of BOP Control Units as per API 16D, API RP16E, API RP53, Shell, Aramco, Norsok, PDO and others
- ◆ Inspection and Certification of BOP Control Units to meet the above specifications
- ◆ Repair & Testing of High Pressure Test Units
- ◆ Repair & Testing of Hydraulic Power Units
- ◆ Repair, Testing & Certification of Swivel Joints, Pup Joints, Loops, Spools, Flanges, Crosses, Tees, DSAF, etc.
- ◆ Our experienced team of service engineers and technicians have the ability to undertake these jobs at customer sites as well

Who we are:

Established in 1943, the Windlass group of companies specializes in many fields and lays strong emphasis on quality, research & development and customer service. Our companies are proud to have earned multiple export awards.

Our divisions include:

- ◆ Windlass Steelcrafts, India - Manufacturer of swords, armor and handicrafts
- ◆ Windlass Engineers & Services, USA and India - Manufacturer and distributor of oilfield equipment
- ◆ RS Windlass & Sons, India - Apparel manufacturer and exporter
- ◆ Windlass Realtors & Developers, India - Real estate development
- ◆ Atlanta Cutlery Corporation, USA - Military contractor & specialty retailer

Quality comes from a passion for Creating Excellence

Our quality and customer focus are evident in everything we design, manufacture, test and deliver. It is this emphasis on quality, innovative technology and complete end-to-end manufacturing solutions that drive our business and provide our customers with significant competitive advantages in the global marketplace. At the heart of the company is a team of skilled, dedicated and highly qualified workforce with decades of experience in oilfield equipment manufacturing. Our entire team is committed to providing customers with unrivaled expertise, service and support.

For more information, please visit

www.windlassengineers.com

DRILLING BOP CONTROL SYSTEMS

Windlass BOP Control Systems meet or exceed the most stringent quality standards including American Petroleum Institute specifications API 16D, RP16E & RP53 to assure safe and reliable operation under critical conditions. We provide BOP Control Systems for both onshore and offshore applications worldwide.

Our BOP Control Systems are custom designed and manufactured to meet customers' requirements and certifications.

Our Design department is well equipped with the best tools and software for designing these units and each unit undergoes extensive tests and checks before dispatch to ensure trouble free operation to minimize rig shutdown time and ensure greater safety for the drilling crew.

We can also upgrade and refurbish an obsolete unit as per API 16D or any other similarly recognized standard. All of which are supported by the Windlass field service network of engineers and technicians with extensive knowledge of electrical, hydraulic and pneumatic systems.



Windlass BOP Control Systems are highly customizable. The following sections describe some of the options available on each subassembly. You can always contact us with your requirements and we can design the entire system for you.

ACCUMULATOR MODULES

The Accumulator Module consists of a welded structural steel skid assembly with a fluid reservoir, provisions for mounting the electric pump, air pump system, hydraulic control manifold, interface module and the type and quantity of accumulators.

TYPES OF MODULES

- ◆ **M-SERIES**
The M-Series Accumulator Module has standard features and is a quality economical choice
- ◆ **T-SERIES**
The T-Series Accumulator Module has advanced safety features and is additionally equipped with a reservoir level sight gauge and 14 inch x 14 inch clean-out man-way for reservoir maintenance

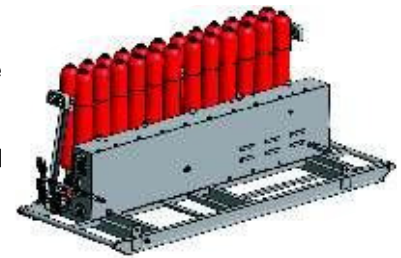

Model Number Designation

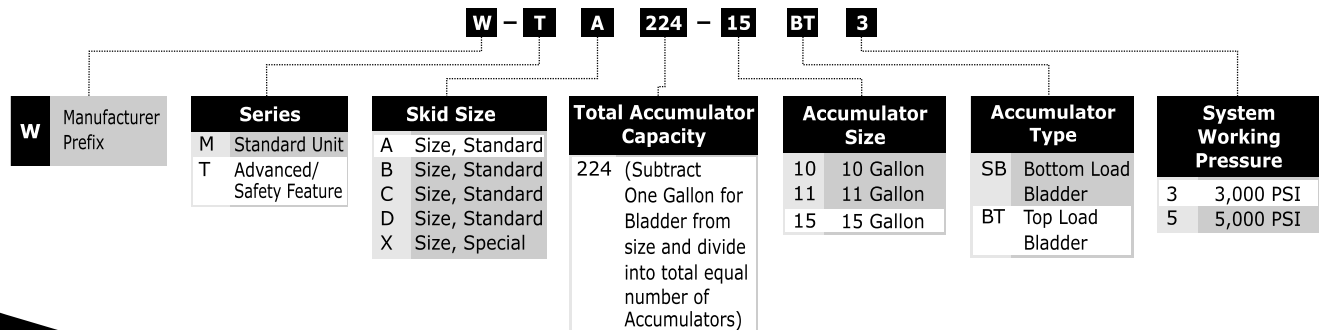

ELECTRIC MOTOR DRIVEN PUMP MODULES

The Electric Motor Driven Pump Module is the primary source for generating hydraulic energy which is stored in the accumulators to operate the BOP stack. These pumps are offered in a variety of options and operating voltages to meet customer requirements.

- ◆ Standard Electric Pump Module is designed for operation in hazardous locations where the presence of explosive gases is anticipated and includes automatic electric explosion-proof starters, motors and pressure switches. Electrical components that meet NEMA, NEC and UL specifications are standard in these modules
- ◆ The Electric Pump Module is set to automatically stop when system reaches working pressure and restart when system pressure drops to 10% below working pressure
- ◆ Each Electric Pump Module is sized to meet the greater of the following two conditions:
 - a. Close the specific annular preventer in use and open the hydraulic-actuated choke valve within two minutes (with the accumulators blocked)
 - b. Charge the accumulators from zero to working pressure in less than fifteen minutes

TYPES OF MODULES

◆ T-SERIES

- The T-Series Electric Driven Pump has a triplex plunger
- The electric motor is horizontally mounted but can be vertically mounted over the pump in order to meet the length restrictions
- The motor is mechanically coupled to the pump drive by a rugged chain and sprocket drive assembly specifically designed for the working horsepower of the assembly
- The drive assembly is encased in an oil bath protective guard to ensure years of hassle-free operation

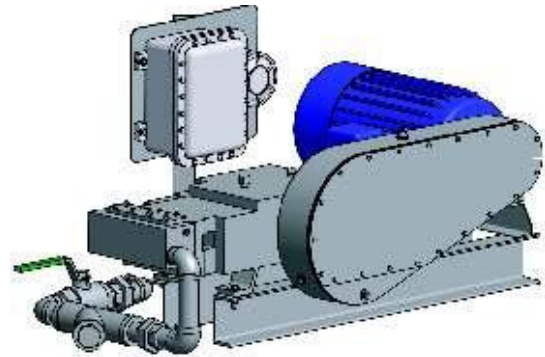

◆ M-SERIES

This pump module has the same features as the T-Series but is limited to 20 Horsepower by plunger load design specifications

◆ S-SERIES

This pump module has the same features as T-Series but comes with a special drive

Model Number Designation

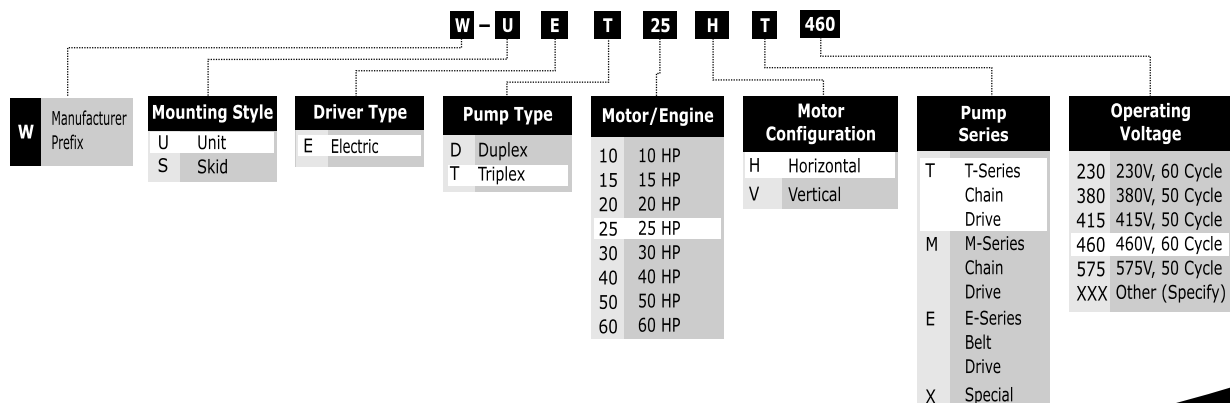

AIR OPERATED PUMP MODULES

Air Operated Pump Module is the secondary source used to provide high pressure fluid energy to charge the accumulator and operate the BOP stack functions.

- ◆ Air Pump Module is supplied in many options to meet the specifications and economic requirements of the customer
- ◆ The design performance ratios offered ensure that the rig air supply system is not overburdened while at the same time the system can still develop the hydraulic system operating pressure even in the event of low rig air pressure flow
- ◆ Air Pump Module has a hydro pneumatic pressure valve which is set to stop the pumps at slightly below operating pressure and restart automatically when system pressure falls to approximately 400 PSI

TYPES OF MODULES

◆ T-SERIES

This series features a Super Sixty (60:1) pump ratio with self adjusting packing and tungsten carbide valve seats driven by an 8-1/2" air motor producing the highest flow rate

◆ M-SERIES

This series features the same fluid end design as the T-Series but with pumps available in 7-3/8" air motor

◆ E-SERIES

This economy series maintains the ability to reach system opening pressure even if the rig air supply pressure is low. This module is available with a 6 inch air motor

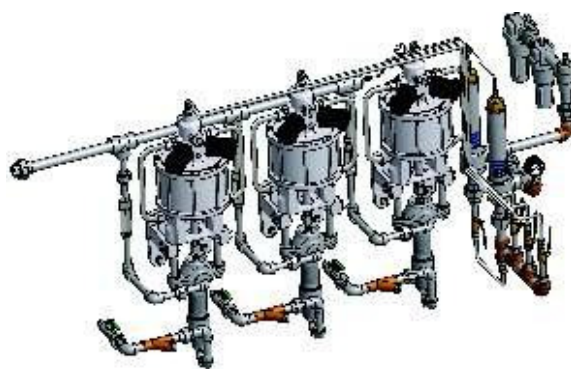

Model Number Designation

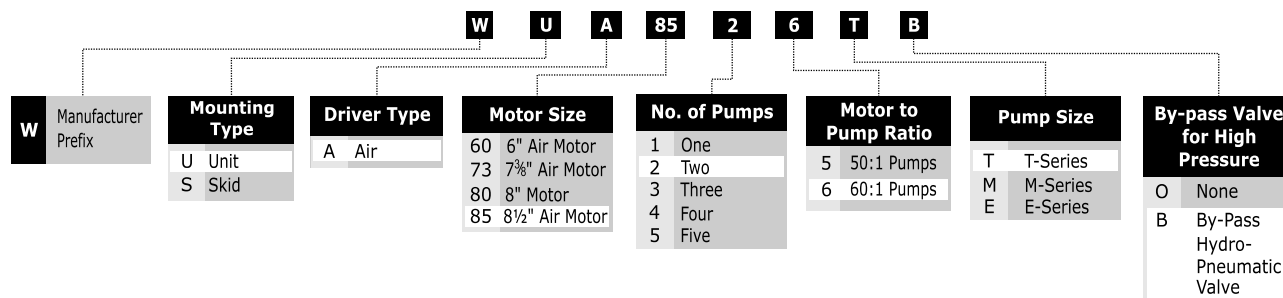

UNIT MOUNTED HYDRAULIC CONTROL MANIFOLD

TYPES OF MODULES

◆ T-SERIES

The T-series Hydraulic Control Manifold provides safe, dependable operation for control of the BOP stack utilizing and having the following features:

- Sub-plate mounted control valves
- Separate circuits provide independent pressure regulation and control for the annular preventer, ram and HCR valve

- 1 inch full flow controlling annular preventer for up to 36 gallons closing capacity and 1-1/2 inch for over 36 gallons
- The manifold functions are supplied through the 3 inch machined manifold rated for 3,000 PSI or 5,000 PSI working pressure
- The internal override feature of the regulator permits immediate working accumulator pressure to the manifold, doubling the closing force on the rams in an emergency
- The manifold directional control valves and outlet piping to the preventers are rated for 3,000 PSI or 5,000 PSI working pressure
- These manifolds are available with glycerin-filled, panel-mounted, direct reading gauges indicating manifold regulated, annular regulated and accumulator pressures
- When hydro-pneumatic valve by-passes are selected in the air pump assemblies, this series manifold can be used for testing up to 5,000 PSI and extreme well control problems

◆ **M-SERIES**

- The M-Series Hydraulic Control Manifold differs from the T-Series Manifolds only in that the control valves are directly plumbed into the circuits instead of being sub-plate mounted. This makes the unit easier to service and repair
- These four way selector valves and manifolds are also rated for 3,000 PSI or 5,000 PSI working pressure

◆ **E-SERIES**

The E-Series Hydraulic Control Manifolds are rated for 3,000 PSI. Outlet pipes to the BOP stack are rated for 3,000 PSI working pressure

Model Number Designation

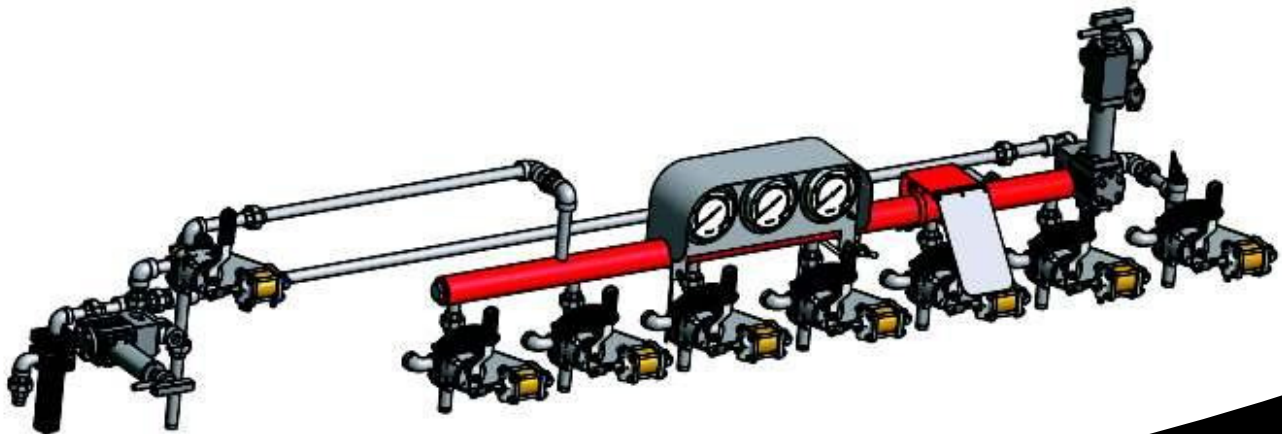
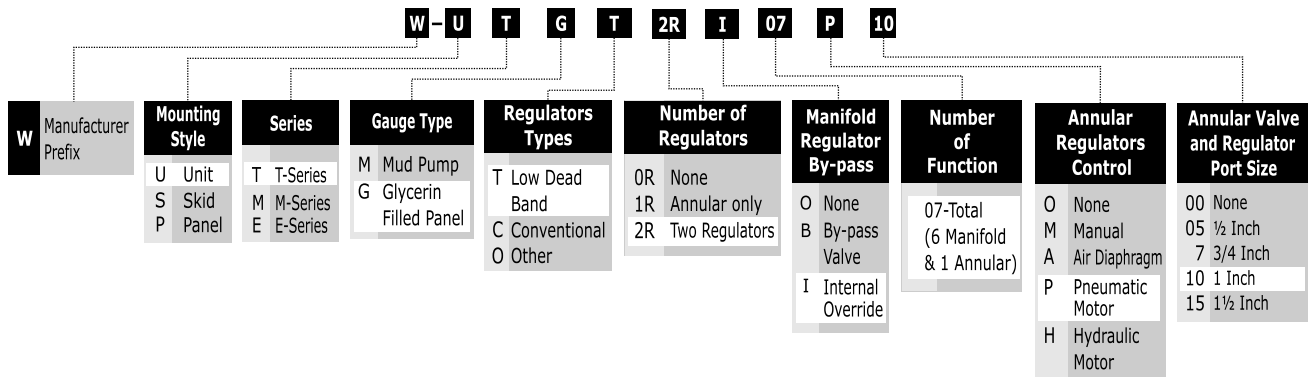

INTERFACE MODULES

The Interface Module is mounted on the BOP Control System and provides remote control capability of hydraulic control manifold functions.

TYPES OF MODULES

◆ A-SERIES

The A-Series Interface Module is applicable for air remote panels only and contains no solenoid valves or transducers. When "AE" or "AA" operation is selected, pressure switches are provided in an explosion-proof enclosure to operate function position, lights and alarms as applicable



◆ T-SERIES

- This series module contains solenoid valves, pressure switches, transducers, transducer power supply for ram indication and pressure indication
- This series has a safety alarm system that provides signals to the remote panel to indicate low reservoir fluid level, low accumulator pressure and low rig air supply pressure
- All the above components are encased in an explosion-proof junction box
- Air cylinders are provided for actuation of the manifold control valves and junction connections to interface with the remote panel through the interconnect assembly

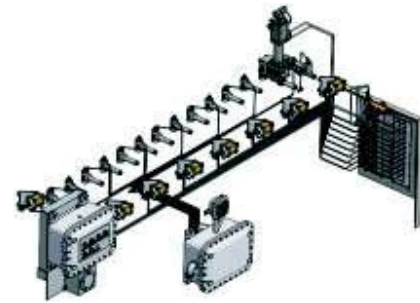

◆ M-SERIES

The M-Series Interface Module provides the same features as the T-Series but does not include the safety alarm

◆ E-SERIES

The E-Series Interface Module provides the same functions as the M-Series but can only be deployed in non-hazardous areas

◆ P-SERIES

The P-Series Interface Module has the same features as the T-Series but the enclosure is air purged to make it explosion-proof

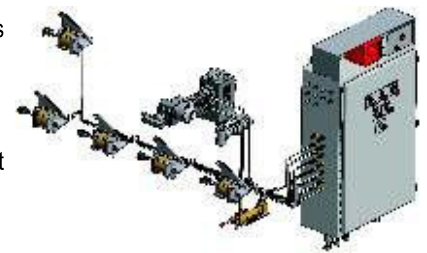

◆ I-SERIES

The I-Series (increased safety) Module is available to meet specific requirements

Model Number Designation

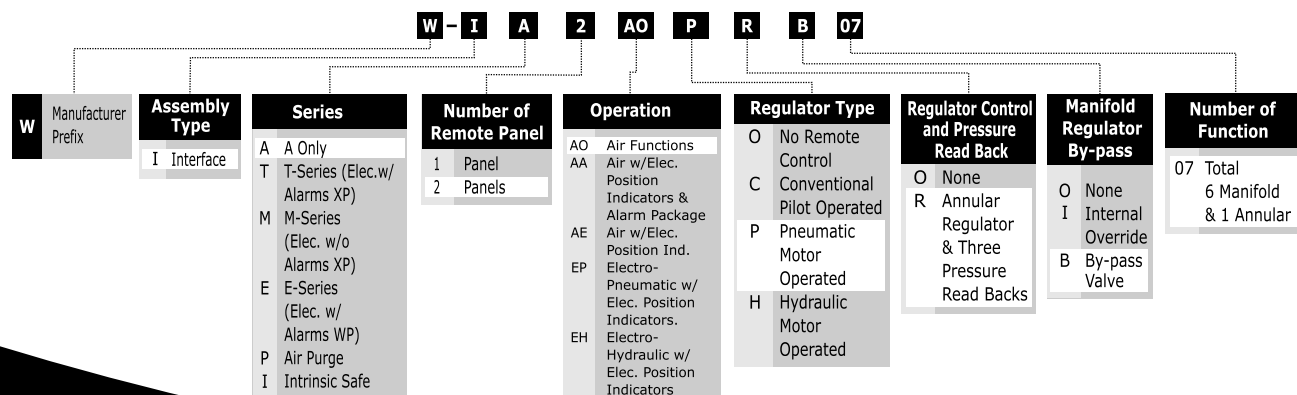

REMOTE CONTROL PANELS

Located a safe distance from the rig floor to ease space restrictions and increase safety, Remote Control Panels give the driller complete control of the BOP stack and provide intuitive operation of the BOP Control System with its hydraulic control manifold.

◆ DRILLER REMOTE PANEL

- Easily accessible to the driller
- This panel is located at the driller station and is capable of operating every BOP stack function, controlling regulated pressure to the annular preventer for stripping operation and is capable of immediately switching from regulated pressure to the full accumulator pressure to the RAM preventer. It can also provide additional closing force that may be required during extreme well control conditions
- This panel includes gauges or meters for remote indication of the various operating pressures and open-close status of the manifold control valves position

◆ AUXILIARY REMOTE PANEL

A second Remote Panel is recommended near the emergency exit or in a safe location from where the BOP stack can be controlled. Should the drilling crew have to evacuate the drill floor, they will still be able to operate all the BOP functions

At least one Remote Control Panel is required in order to comply with API 16 D, RP53, API- RP-16E

Remote Panels used for offshore installations must have meters to indicate pressure, alarm indicators and position status indication at the driller's position

TYPES OF REMOTE CONTROL PANELS

◆ AIR REMOTE PANEL

- Air Remote Panel controls rig air pressure to the cylinders on the control valve of the hydraulic control manifold to operate the manifold functions
- An air interface module is required on the accumulator unit and an air interconnect is required to connect the Air Remote Panel to the interface module
- Air-electric panels additionally have explosion-proof light stations for every BOP stack function to indicate open-close status of the hydraulic manifold valves



◆ ELECTRIC REMOTE PANEL

- Electric Remote Panels provide remote control signals to the electro-pneumatic or electro-hydraulic interface module on the accumulator unit which in turn control the hydraulic control manifold functions
- Electric Remote Control Panel ensures fast, dependable operations and minimizes installation requirements
- Each electric panel includes an indicator light to indicate the function status of the hydraulic control manifold valves
- Electric Remote Panels are available in weather proof, explosion-proof, air purge or intrinsic safe models



◆ PLC REMOTE PANEL

- PLC based Remote Control Panels have a programmable logic controller (PLC) which receives input signals from the BOP Control Unit, processes this information in real time using the structure and rules entered into the program and then issues control commands that operate the BOP Control Units. These PLC panels are designed to meet the recommendations of API RP/4F



- Suitable for use in hazardous locations with option of pressurized enclosure or cast aluminum enclosure
- All panel control functions are two handed to avoid accidental operation
- Electrical components, panel etc. used in and exposed to hazardous atmospheres are designed as per API RP 500 and IEC529 and certified as suitable for use in hazardous locations
- Panel display is physically arranged as a graphical representation of the BOP stack
- Push buttons for open-close function with indicator lights for all BOP functions
- Transparent safety cover which does not obstruct visibility of function is provided to avoid uninterrupted operation of critical functions
- Audible and visual alarms indicate:
 - Low accumulator pressure
 - Low rig air pressure
 - Low hydraulic fluid reservoir level
 - Panel on standby power
- Equipped with displays for the following:
 - Accumulator pressure
 - Manifold regulated pressure
 - Annular BOP regulated pressure
 - Rig air pressure
- Customizable and extensible programming using ladder logic
- Fully customizable and expandable
- Option for Ethernet, Genius Bus, Mod Bus Communication Protocols
- Touch screen suitable for rough environmental conditions, viewable under the sun's glare with excellent optical properties that can be operated even with gloves. Displays the following data:
 - Pressure display for accumulator, manifold, annular and rig air pressure in digital or analog view
 - Displays of function fail alarms
 - Pressure can be displayed in selectable option on screen
 - Setting of different alarm and pressure rating
 - Monitoring, reporting and data logging with date, time and alarms
 - Electrical pumps running indication and cut-off to shut down the pumps before cavitation can occur

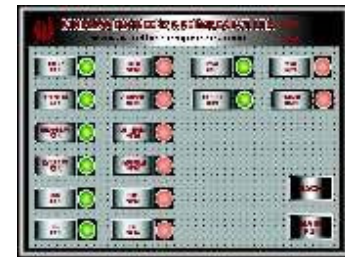
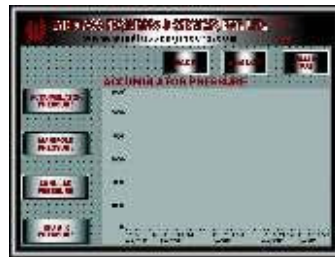

Model Number Designation

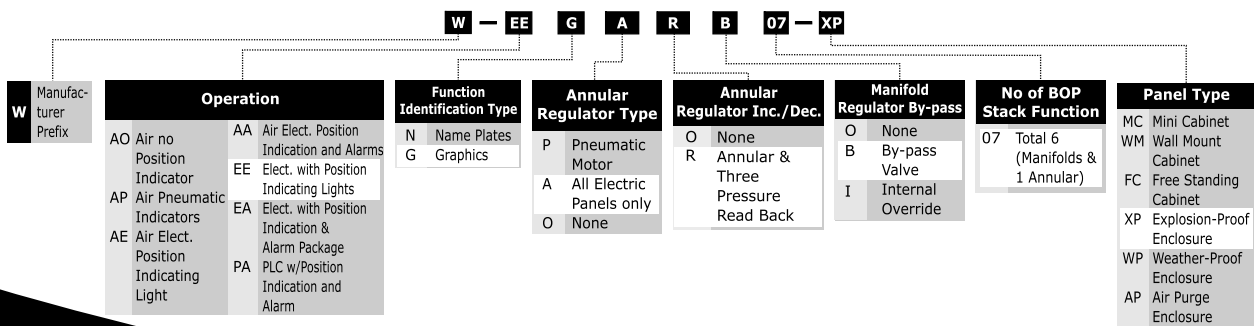

◆ **INTERCONNECT CABLE ASSEMBLIES**

- Air interconnect bundle assemblies are used to carry signals from the air operated remote control panels to the air interface assemblies on the accumulator unit
- It includes a customer specified length of flame resistant multi-tube air bundle
- The junction boxes consist of a hose half of an air junction box on each end which connects to the fixed plate halves mounted on the air panels and on the air interface assemblies
- Electric Interconnect Cable Assemblies are used to carry signals from the electric control interface panels to the electric remote interface assemblies on the accumulator unit which includes customer specified length of electric cable terminated to cable connector plugs

Model Number Designation

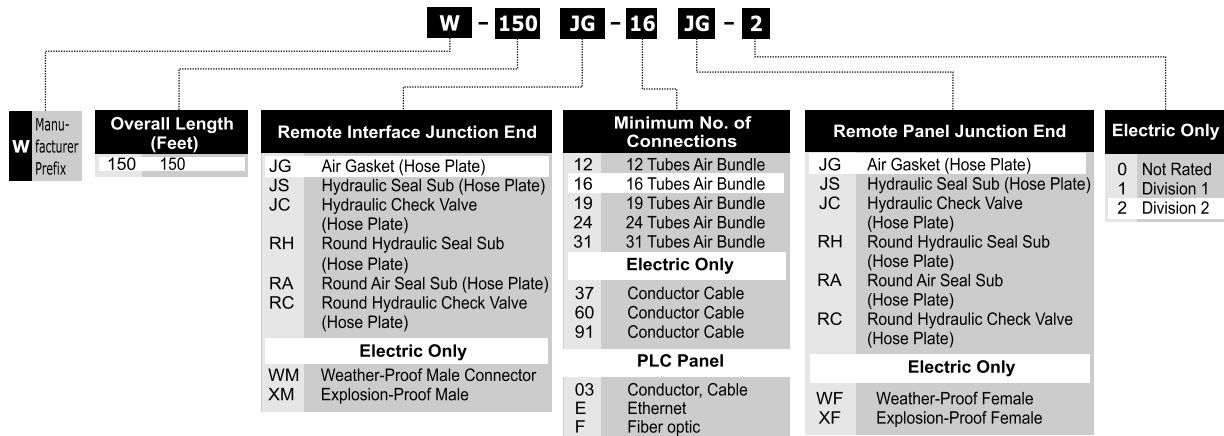

WORKOVER BOP CONTROL SYSTEMS

The W-series Workover BOP Control Systems manufactured by Windlass combine the most advanced technology and quality components with a realistic approach to solving the application and space limitations encountered in today's highly mobile workover environment. We produce a wide variety of Workover Control Units to meet the requirements for large workover rigs down to the smallest truck mounted rig. Each system consists of an accumulator module, high pressure pump and hydraulic control manifold.



◆ **SERIES OFFERED**

- LW (Low Profile Workover)
- SW (Slim Profile Workover)
- CW (Conventional Workover)

Model Number Designation

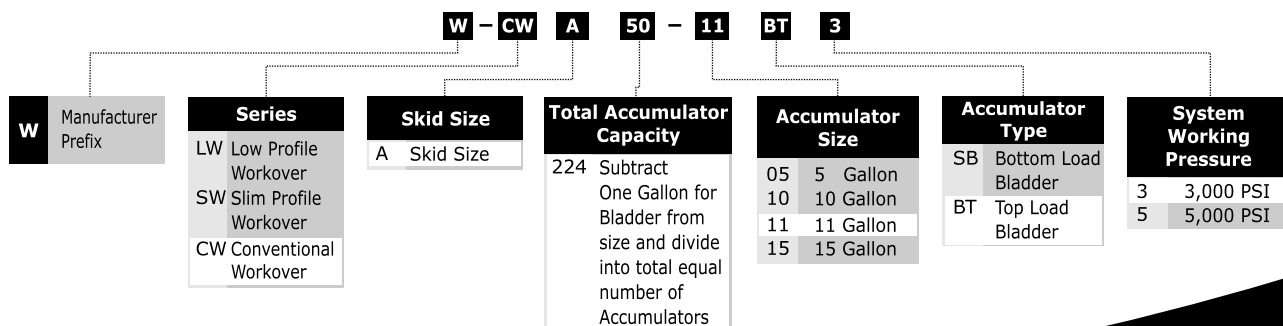

DIVERTER CONTROL PANELS

Windlass manufactures Diverter Control Panels that meet or exceed API 16D requirements.

- ◆ Depending on customer preferences, we provide systems that are either independent of the main hydraulic control unit or a panel driven off the main unit
- ◆ Each panel can be mounted integrally or separately
- ◆ We offer 3/4" or 1-1/2" regulator and 1/2" or 1-1/2" 4-way control valve for diverter controls
- ◆ Includes heavy duty gauges, air cylinders for remote operations and PLC communication to the driller's panel
- ◆ If remote pressure regulation is needed, diverter controls are furnished with an air pilot regulator. This unit features a unit/remote selector valve and pneumatic transmitter



Hydraulic diverter controls can be supplied in free-standing rig floor panel design. This panel, with graphic representation of the diverter installation, includes:

- ◆ Pressure regulators
- ◆ Gauges and control valves
- ◆ Bladder type accumulator furnished for surge dampening
- ◆ Air cylinders if remote operation is needed
- ◆ Hydraulic supply and return connections as well as connections for remote panel operation

SUBSEA EQUIPMENT

Windlass manufactures the following modules and components for Subsea BOP Control Systems:

- ◆ Hydraulic Power Units
- ◆ Hydraulic Control Panels
- ◆ Accumulator Bottle Rack
- ◆ PLC Remote Panels
- ◆ Three Position Air Cylinders
- ◆ RBQ Receiver Plates



HIGH PRESSURE TEST UNITS

Windlass manufactures High Pressure Test Units from 5,000 to 30,000 PSI working pressure. These units can be used on site for hydrostatic testing of any product including BOP stacks, kill & choke lines and wellheads.

Available styles:

- ◆ Portable Trolley Mounted Test Units
- ◆ Skid Mounted Test Units (without tank)
- ◆ Skid Mounted Self Contained Test Units (with tank)
- ◆ Custom Test Units
- ◆ BOP Control Unit Mounted Test Units

MODEL NUMBER IDENTIFICATION

All High Pressure Test Units are equipped with a nameplate specifying the model number. This number contains the mounting arrangement, maximum pressure rating, type of pressure readout and series identification.

Model Number Designation

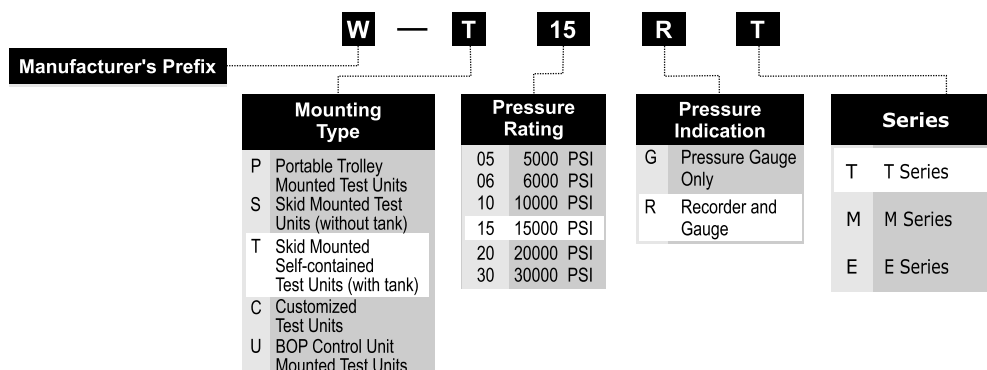

◆ PORTABLE TROLLEY MOUNTED TEST UNITS

These Test Units consist of a single pump mounted on a frame and wheel assembly. Inflatable wheels allow these Test Units to be easily transported to and from the test site. Pressure ratings are limited to 5,000 and 6,000 PSI due to weight considerations



Specifications

Model Number	Maximum Pressure (PSI)	Approximate Dimensions						Approximate Weight	
		Length		Width		Height		Pounds	Kg.
		Inches	Cm.	Inches	Cm.	Inches	Cm.		
W-P05G-T	5000	40	102	30	76	44	112	231	105
W-P06G-T	6000	40	102	30	76	44	112	231	105

◆ SKID MOUNTED TEST UNITS (WITHOUT TANK)

These Test Units provide versatile service in all static, high pressure testing applications. Equipment can be safely tested up to 30,000 PSI with its compact easy to operate design. They include high pressure air operated pumps, valves and fittings to ensure trouble-free operation. They also include all necessary controls and safety devices as well as connections for the air and fluid supply lines



Specifications

Model Number	Maximum Pressure (PSI)	Approximate Dimensions						Approximate Weight	
		Length		Width		Height		Pounds	Kg.
		Inches	Cm.	Inches	Cm.	Inches	Cm.		
W-S10G-M	10000	42	107	30	76	48	122	440	200
W-S15G-M	15000	42	107	30	76	48	122	440	200
W-S20G-M	20000	42	107	30	76	48	122	440	200
W-S30G-M	30000	42	107	30	76	48	122	451	205

◆ SKID MOUNTED SELF CONTAINED TEST UNITS (WITH TANK)

Self Contained, Tank Mounted Test Units consist of the basic skid-mount with a 50 gallon reservoir and 1/2 inch four-way control valve. This added feature provides convenient control for testing valves. Tests up to 30,000 PSI can be conducted quickly and safely. Using a separate circuit, high volume and low pressure can be created to test valves or the open and close operation of a preventer



Specifications

Model Number	Maximum Pressure (PSI)	Approximate Dimensions						Approximate Weight	
		Length		Width		Height		Pounds	Kg.
		Inches	Cm.	Inches	Cm.	Inches	Cm.		
W-T10G-M	10000	60	152	48	122	54	137	935	425
W-T15G-M	15000	60	152	48	122	54	137	935	425
W-T20G-M	20000	60	152	48	122	54	137	935	425
W-T30G-T	30000	60	152	48	122	54	137	946	430

◆ CUSTOM TEST UNITS

These Test Units are designed according to customer requirements. These unique designs can include control panels, ultra high pressure testing and such customizations based on customer needs



◆ BOP CONTROL UNIT MOUNTED TEST UNITS

This style of Test Unit offers the convenience of being incorporated into the air operated pump assembly of the BOP control system. These units utilize the discharge of one of the BOP control systems pumps as the supply to the high pressure pump. The suction line is modified to include a supply connection for testing

Specifications

Model Number	Maximum Pressure (PSI)	Approximate Dimensions						Approximate Weight	
		Length		Width		Height		Pounds	Kg.
		Inches	Cm.	Inches	Cm.	Inches	Cm.		
W-U10G-M	10000	24	61	30	76	46	117	61	28
W-U15G-M	15000	24	61	30	76	46	117	61	28

ACCESSORIES



www.mysh.mx ventas@mysh.mx

◆ CHART RECORDERS

To be used in conjunction with pressure gauges to provide a documented test record of the equipment being tested. They are available in models ranging from 15,000 to 30,000 PSI with options for mechanical spring or battery drive and rotation of 96 min., 24 hr. or 8 day

Chart Recorders are available in two styles:

- Skid Mounted
- Stand Mounted

Main features include:

- 15,000, 20,000 and 30,000 PSI models
- Clock rotation of 96 minutes, 24 hrs. or 8 days
- Accuracy +/- 1.0% full scale
- 12" chart
- Disposable pens



Specifications

Model Number	Maximum Pressure (PSI)	Approximate Dimensions						Approximate Weight	
		Length		Width		Height		Pounds	Kg.
		Inches	Cm.	Inches	Cm.	Inches	Cm.		
SSR-15	15,000	24	61	24	61	36	91	45	20
SSR-20	20,000	24	61	24	61	36	91	45	20
SSR-30	30,000	24	61	24	61	36	91	45	20

◆ HIGH PRESSURE TEST HOSES

A variety of Test Hoses are available for use in connecting Test Units to the equipment being tested

Main features include:

- 5,000 to 30,000 PSI working pressure
- 10 to 100 feet lengths. Custom lengths also available
- 10,000 PSI and over are wire braided for increased safety
- Quick disconnect couplings for fast connections



HAMMER UNIONS

Windlass offers a comprehensive range of standard and sour gas Hammer Unions. Each union is thoroughly inspected to ensure long, dependable service in the most extreme conditions. Available in stock at our distribution center in Houston.

- ◆ Three lug nuts and self-locking ACME threads provide quick make-up and break-out
- ◆ Color coded for quick identification
- ◆ Unique identification for sour gas unions
- ◆ Meet or exceed National Association of Corrosion Engineers standard NACE MR-01-75 and API RP-14E
- ◆ Manufactured from quality steel meeting ASTM and/or AISI standards
- ◆ All unions provide pressure-tight & positive sealing for low-pressure services (500 to 2,000 PSI)
- ◆ The spherical surface male sub and angular surface female sub form a metal-to-metal seal, the ball and tangent provides a perfect seal
- ◆ Range from 1/2" to 12" with cold working pressures from 500 to 20,000 PSI
- ◆ Fully interchangeable with most major brands of Hammer Unions



Specifications For Threaded and Butt Weld Hammer Unions

Fig. No.	Assembly Color Code for Standard Service	Pressure Rating (PSI)				Nominal Pipe Sizes															
		Standard Service		Sour Gas Service		(in.)	1/2	1	1-1/4	1-1/2	2	2-1/2	3	4	5	6	8	10	12		
		Cold Working	Test	Cold Working	Test	(mm)	13	25	32	38	50	65	80	100	125	150	200	250	300		
50		500	750	N/A	N/A																
100		1,000	1,500	N/A	N/A																
101		1,000	1,500	N/A	N/A																
200		2,000	3,000	2,000	3,000																
201		2,000	3,000	2,000	3,000																
206		2,000	3,000	2,000	3,000																
207		2,000	3,000	2,000	3,000																
211		2,000	3,000	N/A	N/A																
300		2,000	3,000	N/A	N/A																
400		4,000	6,000	4,000	6,000																
602		6,000	9,000	6,000	9,000																
1002		10,000	15,000	7,500	11,250																
1003		10,000	15,000	7,500	11,250																
1004		10,000	15,000	7,500	11,250																
1502		15,000	22,500	10,000	15,000																
2002		20,000	30,000	N/A	N/A																
2202		N/A	N/A	15,000	22,500																
6666		6,000	9,000	N/A	N/A																

* Indicates different Cold Working Pressure due to other design factor - Difference as shown below:
 5", 6", 12" : Figure 400, Cold Working Pressure 2,500 PSI & Test Pressure 4,000 PSI
 5", 6" : Figure 1002 Butt weld, Cold Working Pressure 7,500 PSI & Test Pressure 11,250 PSI Std. Service
 4", 5" : Figure 1003 Butt weld, Cold Working Pressure 7,500 PSI & Test Pressure 11,250 PSI Std. Service
 5", 6" : Figure 1002 Butt weld, Cold Working Pressure 5,000 PSI & Test Pressure 7,500 PSI Sour Service
 4", 5" : Figure 1003 Butt weld, Cold Working Pressure 5,000 PSI & Test Pressure 7,500 PSI Sour Service
 1/2" : Figure 300, Cold Working Pressure 15,000 PSI & Test Pressure 20,000 PSI, Zinc Plated

Fig. 50 Union
Red Nut, Red Subs



Specifications

Size Inches	Nut Radius Inches	Length Total Inches	Pressure Rating (PSI)				Weight (LBS) (Approx.)
			Standard Service		Sour Gas Service		
			Cold Working	Test	Cold Working	Test	
4	5.13	6.20	500	750	N/A	N/A	27.00
5	5.22	5.60	500	750	N/A	N/A	22.40

- ◆ These Hammer Unions are recommended for suction and low pressure lines
- ◆ Available in threaded and socket weld ends

Fig. 100 Union
Black Nut, Yellow Subs



Specifications

Size Inches	Nut Radius Inches	Length Total Inches	Pressure Rating (PSI)				Weight (LBS) (Approx.)
			Standard Service		Sour Gas Service		
			Cold Working	Test	Cold Working	Test	
2	2.90	3.23	1,000	1,500	N/A	N/A	5.63
2-1/2	3.60	4.25	1,000	1,500	N/A	N/A	11.47
3	4.00	4.59	1,000	1,500	N/A	N/A	13.80
4	4.70	4.94	1,000	1,500	N/A	N/A	19.42
5	5.80	6.00	1,000	1,500	N/A	N/A	32.50
6	6.50	6.84	1,000	1,500	N/A	N/A	46.21
8	7.87	7.31	1,000	1,500	N/A	N/A	69.88

- ◆ These Hammer Unions are used in low pressure manifold lines and air, water, oil or gas applications.
- ◆ Available in both threaded and butt weld ends
- ◆ Metal to metal sealing surface

Fig. 101 Union
Beige Nut, Yellow Subs



Specifications

Size Inches	Nut Radius Inches	Length Total Inches	Pressure Rating (PSI)				Weight (LBS) (Approx.)
			Standard Service		Sour Gas Service		
			Cold Working	Test	Cold Working	Test	
5	5.52	8.05	1,000	1,500	N/A	N/A	33.00

- ◆ These Hammer Unions are used in low pressure manifold lines and air, water, oil or gas applications
- ◆ Available in threaded ends
- ◆ Subs with flat face
- ◆ O-ring recommended for line connections where straight breakout of short pipe segments is required

Fig. 200 Union
Blue Nut, Grey Subs



Specifications

Size Inches	Nut Radius Inches	Length Total Inches	Pressure Rating (PSI)				Weight (LBS) (Approx.)
			Standard Service		Sour Gas Service		
			Cold Working	Test	Cold Working	Test	
1	1.96	2.65	2,000	3,000	2,000	3,000	1.75
1-1/4	2.17	2.78	2,000	3,000	2,000	3,000	2.37
1-1/2	2.41	2.98	2,000	3,000	2,000	3,000	3.29
2	2.90	3.17	2,000	3,000	2,000	3,000	5.47
2-1/2	3.63	4.13	2,000	3,000	2,000	3,000	10.00
3	4.26	4.58	2,000	3,000	2,000	3,000	15.03
4	5.00	4.94	2,000	3,000	2,000	3,000	20.95
5	5.50	6.55	2,000	3,000	2,000	3,000	33.26
6	6.43	6.66	2,000	3,000	2,000	3,000	42.50
8	7.43	7.19	2,000	3,000	2,000	3,000	64.00
10	9.00	9.13	2,000	3,000	2,000	3,000	91.00

- ◆ These Hammer Unions are used in general service manifold lines and air, water, oil or gas applications
- ◆ Available in both threaded and butt weld ends
- ◆ Metal to metal sealing surface
- ◆ Available in butt weld schedules 40 and 80

Fig. 201 Union
Gold Nut, Grey Subs



Specifications

Size Inches	Nut Radius Inches	Length Total Inches	Pressure Rating (PSI)				Weight (LBS) (Approx.)
			Standard Service		Sour Gas Service		
			Cold Working	Test	Cold Working	Test	
2-1/2	4.69	6.06	2,000	3,000	2,000	3,000	19.45

- ◆ These Hammer Unions are used in air, water, oil or gas applications
- ◆ Available in threaded ends
- ◆ Subs with flat face
- ◆ O-ring recommended for line connections where straight breakout of short pipe segments is required

Fig. 206 Union
Blue Nut, Grey Subs



Specifications

Size Inches	Nut Radius Inches	Length Total Inches	Pressure Rating (PSI)				Weight (LBS) (Approx.)
			Standard Service		Sour Gas Service		
			Cold Working	Test	Cold Working	Test	
1	1.96	2.65	2,000	3,000	2,000	3,000	1.75
1-1/4	2.17	2.78	2,000	3,000	2,000	3,000	2.37
1-1/2	2.41	2.98	2,000	3,000	2,000	3,000	3.29
2	2.90	3.17	2,000	3,000	2,000	3,000	5.47
2-1/2	3.63	4.13	2,000	3,000	2,000	3,000	10.00
3	4.26	4.58	2,000	3,000	2,000	3,000	15.03
4	5.00	4.94	2,000	3,000	2,000	3,000	20.95
5	5.50	6.55	2,000	3,000	2,000	3,000	33.26
6	6.43	6.66	2,000	3,000	2,000	3,000	42.50
8	7.43	7.19	2,000	3,000	2,000	3,000	64.00
10	9.00	9.13	2,000	3,000	2,000	3,000	91.00

- ◆ These Hammer Unions are similar to Fig 200 with a secondary seal to supplement the metal-to-metal design
- ◆ Recommended for use in corrosive environments
- ◆ Available in both threaded and butt weld ends
- ◆ Available in butt weld schedules 40 and 80

Fig. 207 Union
Blue Nut, Grey Subs



Specifications

Size	Nut Radius	Length Total	Pressure Rating (PSI)				Weight (LBS)
			Standard Service		Sour Gas Service		
Inches	Inches	Inches	Cold Working	Test	Cold Working	Test	(Approx.)
3	2.75	3.87	2,000	3,000	2,000	3,000	9.80
4	3.59	4.38	2,000	3,000	2,000	3,000	16.25
6	4.92	5.60	2,000	3,000	2,000	3,000	45.88

- ◆ Fig 207 Hammer Unions are fully interchangeable with figure 200 and 206 unions
- ◆ Used to blank off the end of a line
- ◆ O-ring is provided in blanking cap to ensure leak proof seal
- ◆ Available in both threaded and butt weld ends
- ◆ Available in butt weld schedules 40 and 80

Fig. 211 Union
Grey Nut, Blue Subs



Specifications

Size	Nut Radius	Length Total	Pressure Rating (PSI)				Weight (LBS)
			Standard Service		Sour Gas Service		
Inches	Inches	Inches	Cold Working	Test	Cold Working	Test	(Approx.)
2	3.03	3.45	2,000	3,000	N/A	N/A	6.60
3	4.27	4.55	2,000	3,000	N/A	N/A	14.08

- ◆ These Hammer Unions are used in production systems with electrolytic corrosive environments
- ◆ No metal to metal contact between the subs
- ◆ Laminated insulating rings provide 35 million Ohms resistance across the union. O-ring in male sub provides a positive primary seal
- ◆ Resilient seal ring in female sub provides secondary protection from corrosion
- ◆ Available in threaded ends

Fig. 300 Union
Grey Nut, Yellow Subs★



Specifications

Size	Nut Radius	Length Total	Pressure Rating (PSI)				Weight (LBS)
			Standard Service		Sour Gas Service		
Inches	Inches	Inches	Cold Working	Test	Cold Working	Test	(Approx.)
1/2	1.80	3.00	15,000	20,000	N/A	N/A	1.80
1	2.13	2.63	2,000	3,000	N/A	N/A	2.00
2	2.88	3.75	2,000	3,000	N/A	N/A	2.50

★ 1/2" Fig 300 Hammer Unions are zinc plated and gray in color

- ◆ These Hammer Unions have a flat face design which permits straight breakout for lateral removal of valves and other fittings for inspection or replacement
- ◆ Available in threaded ends

Fig. 400 Union
Black Nut, Red Subs



Specifications

Size	Nut Radius	Length Total	Pressure Rating (PSI)				Weight (LBS)
			Standard Service		Sour Gas Service		
			Cold Working	Test	Cold Working	Test	
Inches	Inches	Inches					(Approx.)
2	3.54	5.13	4,000	6,000	4,000	6,000	12.46
3	4.17	6.14	4,000	6,000	4,000	6,000	20.13
4	5.04	8.18	4,000	6,000	4,000	6,000	31.24
5	6.70	11.10	2,500	4,000	2,500	4,000	49.60
6	7.70	11.40	2,500	4,000	2,500	4,000	63.47
12	10.26	10.90	2,500	4,000	2,500	4,000	164.90

- ◆ These Hammer Unions are used in manifold & line connections, pump suction and mud services
- ◆ Available in both threaded and butt weld ends
- ◆ 3" through 12" sizes have o-ring for primary seal
- ◆ Available in butt weld schedule 80

Fig. 602 Union
Black Nut, Orange Subs



Specifications

Size	Nut Radius	Length Total	Pressure Rating (PSI)				Weight (LBS)
			Standard Service		Sour Gas Service		
			Cold Working	Test	Cold Working	Test	
Inches	Inches	Inches					(Approx.)
1	2.19	3.53	6,000	9,000	6,000	9,000	3.50
1-1/4	3.08	4.80	6,000	9,000	6,000	9,000	9.01
1-1/2	3.10	4.90	6,000	9,000	6,000	9,000	9.17
2	3.70	5.30	6,000	9,000	6,000	9,000	13.78
3	4.50	6.20	6,000	9,000	6,000	9,000	22.76
4	5.19	8.18	6,000	9,000	6,000	9,000	34.96

- ◆ These Hammer Unions are used in water, oil, gas and mud service
- ◆ Replaceable, lip type rubber seal provides primary sealing
- ◆ Available in both threaded and butt weld ends

Fig. 1002 Union
Red Nut, Blue Subs



Specifications

Size	Nut Radius	Length Total	Pressure Rating (PSI)				Weight (LBS)
			Standard Service		Sour Gas Service		
			Cold Working	Test	Cold Working	Test	
Inches	Inches	Inches					(Approx.)
1	2.19	3.55	10,000	15,000	7,500	11,250	3.50
1-1/4	3.08	4.88	10,000	15,000	7,500	11,250	9.01
1-1/2	3.10	4.90	10,000	15,000	7,500	11,250	9.17
2	3.70	5.30	10,000	15,000	7,500	11,250	13.78
3	4.50	6.20	10,000	15,000	7,500	11,250	22.53
4	5.20	8.20	10,000	15,000	7,500	11,250	34.91
5	6.26	9.13	7,500	11,250	5,000	7,500	66.57
6	7.00	7.60	7,500	11,250	5,000	7,500	92.15

- ◆ These Hammer Unions are used in high pressure applications for choke and kill lines, cementing and acidizing. Replaceable, lip type rubber seal provides primary sealing up to 4"
- ◆ 5" and 6" sizes have o-ring for primary sealing
- ◆ Available in both threaded and butt weld ends
- ◆ 6" unions are only available in butt weld for sour service

Fig. 1003 Union
Black Nut, Green Subs



Specifications

Size	Nut Radius	Length Total	Pressure Rating (PSI)				Weight (LBS)
			Standard Service		Sour Gas Service		
			Cold Working	Test	Cold Working	Test	
Inches	Inches	Inches					(Approx.)
3	4.80	8.87	10,000	15,000	7,500	11,250	47.50
4	6.00	10.90	7,500	11,250	5,000	7,500	78.15
5	6.00	10.90	7,500	11,250	5,000	7,500	79.62

- ◆ These Hammer Unions are used in air, water, oil, mud, gas service, high pressure manifold, drilling rig where alignment of piping components is a problem
- ◆ Replaceable o-ring on male sub provides primary sealing
- ◆ Available in both threaded and butt weld ends
- ◆ 5" unions are available in butt weld ends only

Fig. 1004 Union
Red Nut, Grey Subs



Specifications

Size	Nut Radius	Length Total	Pressure Rating (PSI)				Weight (LBS)
			Standard Service		Sour Gas Service		
			Cold Working	Test	Cold Working	Test	
Inches	Inches	Inches					(Approx.)
5	6.00	8.25	10,000	15,000	7,500	11,250	85.00
6	7.25	9.38	10,000	15,000	7,500	11,250	140.00

- ◆ Available in butt weld ends
- ◆ Face of male & female subs is perfectly square
- ◆ Provided with lip type seal ring

Fig. 1502 Union
Blue Nut, Red Subs



Specifications

Size	Nut Radius	Length Total	Pressure Rating (PSI)				Weight (LBS)
			Standard Service		Sour Gas Service		
			Cold Working	Test	Cold Working	Test	
Inches	Inches	Inches					(Approx.)
1	2.76	4.38	15,000	22,500	10,000	15,000	9.12
1-1/2	3.50	4.50	15,000	22,500	10,000	15,000	16.30
2	4.00	7.00	15,000	22,500	10,000	15,000	20.11
3	4.88	7.64	15,000	22,500	10,000	15,000	34.10
4	6.02	8.57	15,000	22,500	10,000	15,000	72.68
5	6.53	9.00	15,000	22,500	10,000	15,000	95.00
6	7.20	9.75	15,000	22,500	10,000	15,000	145.00

- ◆ These Hammer Unions are used in cementing, acidizing, choke and kill lines
- ◆ Replaceable lip type rubber seal
- ◆ Available in both threaded and butt weld ends

Fig. 2002 Union
Green Nut, Grey Subs



Specifications

Size	Nut Radius	Length Total	Pressure Rating (PSI)				Weight (LBS)
			Standard Service		Sour Gas Service		
Inches	Inches	Inches	Cold Working	Test	Cold Working	Test	(Approx.)
2	2.75	4.67	20,000	30,000	N/A	N/A	8.20
3	3.50	4.50	20,000	30,000	N/A	N/A	16.30
4	4.00	7.00	20,000	30,000	N/A	N/A	21.00

- ◆ Replaceable lip type rubber seal
- ◆ Available in butt weld ends only

Fig. 2202 Union
Green Nut, Green Subs



Specifications

Size	Nut Radius	Length Total	Pressure Rating (PSI)				Weight (LBS)
			Standard Service		Sour Gas Service		
Inches	Inches	Inches	Cold Working	Test	Cold Working	Test	(Approx.)
2	2.75	4.69	N/A	N/A	15,000	22,500	8.20
3	3.50	4.50	N/A	N/A	15,000	22,500	16.40
4	4.00	7.00	N/A	N/A	15,000	22,500	21.50

- ◆ These Hammer Unions are specially designed for sour gas service
- ◆ Replaceable lip type rubber seal with stainless steel anti extrusion ring
- ◆ Conform to NACE standard MR-01-75 and API RP-14E
- ◆ Available in butt weld ends only

Fig. 6666 Union
Brown Nut, Silver Subs



Specifications

Size	Nut Radius	Length Total	Pressure Rating (PSI)				Weight (LBS)
			Standard Service		Sour Gas Service		
Inches	Inches	Inches	Cold Working	Test	Cold Working	Test	(Approx.)
1-1/2"	2.83	4.19	6,000	9,000	N/A	N/A	6.6
2	3.46	5.85	6,000	9,000	N/A	N/A	12.58

- ◆ Available in threaded ends only

Note : Other sizes and end connections for special requirements available upon request. Please contact us at sales@windlassoilequipment.com

HOSE NIPPLE UNIONS

- ◆ Windlass manufactures Hose Nipple Unions from 1" to 4" for all pressure ratings



INTEGRAL BLIND SUBS

- ◆ Windlass manufactures Blind Male and Female Subs with NPT ports with or without SS chain for all sizes ranging from 1" to 10" for all pressure ratings



O-RINGS & SEAL RINGS

- ◆ O-Rings & Seal Rings for hammer unions are available in nitrile for standard service and viton for H2S service
- ◆ O-Rings for hammer seal unions are available in stock at our distribution center in Houston

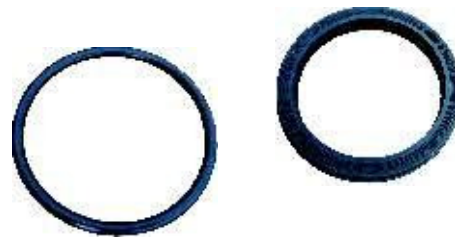

RETAINER RINGS & RETAINER SEGMENTS

- ◆ Retainer Rings and Retainer Segments are used for assembly of a wing nut with a male end of hammer union. These are manufactured in all sizes and figure of hammer unions



HAMMER SEAL UNIONS

- ◆ Designed to quickly connect mud tanks with flanged connections
- ◆ Nitrile o-ring provides a compressive non leak seal that limits the line fluid pressure to 150 PSI
- ◆ Tank Unions accept up to 7° of pipe misalignment
- ◆ The female sub of the hammer seal union welds to a schedule 40 / 80 pipe
- ◆ Available in stock at our distribution center in Houston

Specifications

Size	Nut Radius	Total Length	Weight
(Inches)	(Inches)	(Inches)	(LBS)
	L	L1	(Approx.)
4	5.31	3.67	22.05
6	6.57	5.22	33.07
8	7.71	5.24	43.65
10	8.86	5.24	52.03
12	9.84	5.19	63.71
14	10.59	4.67	73.48



Grey Nut
Grey Sub

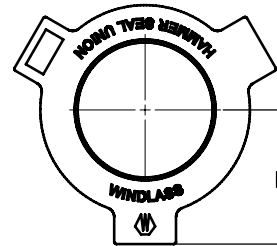

SPOOLS- DRILLING, ADAPTER & SPACER

- ◆ Windlass manufactures Drilling Spools as per API 16A and Adapter & Spacer Spools as per API 6A. These are manufactured as per customer configuration



PLUG VALVES

- ◆ Windlass high pressure low torque Plug Valves are available in 2" X 2" and 2" X 1". They come in multiple bores and are available up to 15,000 PSI for standard service and 10,000 PSI for H2S or sour gas service. Our plug valves are pressure balanced type and have replaceable metal liners between the body and plug. Repair kits are also available to increase their life and make them perform safely for longer. These manually operated valves are fitted with high stem torques and manual gearboxes
- ◆ These Plug Valves are designed to meet the needs and requirements of the oilfield. They can withstand the high erosion rates and pressures encountered in today's operating environment
- ◆ Available in stock at our distribution center in Houston



CLAMPS & HUBS

Windlass manufactures the complete range of Clamps & Hubs in accordance with API 16A.

- ◆ Clamps allow fast and easy make up even in limited space. All Windlass Clamps have 360° adjustability
- ◆ Windlass Clamps reliably connect Hubs and other API connections
- ◆ Windlass manufactures Hubs & Clamps with pressure ratings from 2,000 PSI to 20,000 PSI
- ◆ Hubs & Clamps are designed & manufactured in accordance with the following specifications :
 - Temperature rating (T-0, T-20, T-40)
 - Physical properties comply to API 16A requirement
- ◆ Windlass manufactures Clamps from No.1 to No. 15
- ◆ Type 16B & 16BX Hubs are of the ring joint type and are designed for face to face make-up

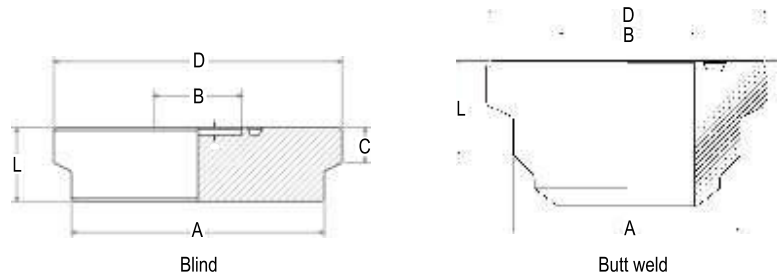

Specifications for Hubs

API Type 16B Integral Hub Connections for 2,000 PSI & 3,000 PSI Rated Working Pressure						
Nominal Size and Bore B (Inches)	Outside Diameter D (Inches)	Total Thickness C (Inches)	Large Diameter of Neck A (Inches)	Neck Length for Clamp Clearance L (Inches)	Ring Gasket Number	Clamp Number
2,000 PSI						
7-1/16	10.375	1.443	8.875	2.50	RX-45	25
16-3/4	20.375	1.269	19.000	3.13	RX-65	12
21-1/14	26.375	1.872	24.500	5.00	RX-73	18
3,000 PSI						
11	15.626	1.399	14.000	3.13	RX-53	9
13-5/8	18.375	1.336	16.750	3.19	RX-57	11
16-3/4	21.250	1.459	19.625	3.68	RX-65	14

API Type 16BX Integral Hub Connections for 5,000 PSI Rated Working Pressure						
Nominal Size and Bore B (Inches)	Outside Diameter D (Inches)	Total Thickness C (Inches)	Large Diameter of Neck A (Inches)	Neck Length for Clamp Clearance L (Inches)	Ring Gasket Number	Clamp Number
5,000 PSI						
2-1/6	5.031	1.166	3.656	2.22	BX 152	1
2-9/16	5.781	1.166	4.406	2.27	BX 153	2
3-1/8	6.312	1.166	4.938	2.36	BX 154	4
4-1/16	7.625	1.197	6.250	2.38	BX 155	5
7-1/16	13.250	1.622	11.625	3.38	BX 156	8
9	13.250	1.622	11.625	3.38	BX 157	8
11	16.250	1.654	14.625	4.13	BX 158	10
13-5/8	20.625	1.871	19.000	4.88	BX 160	13
16-3/4	25.625	1.778	24.000	5.50	BX 162	19
21-1/4	31.250	3.630	27.875	6.75	BX 165	27

API Type 16BX Integral Hub Connections for 10,000 PSI Rated Working Pressure						
Nominal Size and Bore B (Inches)	Outside Diameter D (Inches)	Total Thickness C (Inches)	Large Diameter of Neck A (Inches)	Neck Length for Clamp Clearance L (Inches)	Ring Gasket Number	Clamp Number
10,000 PSI						
1-13/16	5.031	1.166	3.656	2.22	BX 151	1
2-1/16	5.781	1.166	4.406	2.27	BX 152	2
2-9/16	6.312	1.166	4.938	2.36	BX 153	4
3-1/16	7.625	1.197	6.250	2.38	BX 154	5
4-1/16	8.437	1.310	6.812	2.82	BX 155	6
7-1/16	16.250	1.653	14.625	4.13	BX 156	10
9	16.250	1.653	14.625	4.13	BX 157	10
11	20.625	2.035	18.625	4.75	BX 158	22
13-5/8	22.250	2.309	20.625	5.31	BX 159	15
16-3/4	28.000	3.005	25.000	6.17	BX 162	28
18-3/4	31.250	3.630	27.875	6.75	BX 164	27
21-1/4	34.000	4.005	30.500	8.22	BX 166	26

API Type 16BX Integral Hub Connections for 15,000 PSI Rated Working Pressure						
Nominal Size and Bore B (Inches)	Outside Diameter D (Inches)	Total Thickness C (Inches)	Large Diameter of Neck A (Inches)	Neck Length for Clamp Clearance L (Inches)	Ring Gasket Number	Clamp Number
15,000 PSI						
1-13/16	5.781	1.166	4.406	2.27	BX 151	2
2-1/16	6.125	1.622	4.500	3.22	BX 152	3
2-9/16	6.125	1.622	4.500	3.22	BX 153	3
3-1/16	8.437	1.310	6.812	2.82	BX 154	6
4-1/16	13.250	1.622	11.625	3.38	BX 155	8
7-1/16	20.626	2.035	18.625	4.75	BX 156	22
11	22.250	2.309	20.625	5.31	BX 158	15
13-5/8	28.000	3.005	25.000	6.17	BX 159	28
18-3/4	34.000	4.005	30.500	8.22	BX 164	26

API Type 16BX Integral Hub Connections for 20,000 PSI Rated Working Pressure						
Nominal Size and Bore B (Inches)	Outside Diameter D (Inches)	Total Thickness C (Inches)	Large Diameter of Neck A (Inches)	Neck Length for Clamp Clearance L (Inches)	Ring Gasket Number	Clamp Number
20,000 PSI						
1-13/16	6.125	1.622	4.500	3.22	BX 151	3
2-1/16	6.125	1.622	4.500	3.22	BX 152	3
2-9/16	8.437	1.310	6.812	2.82	BX 153	6
3-1/16	13.250	1.622	11.625	3.38	BX 154	8
4-1/16	16.250	1.653	14.625	4.13	BX 155	10
7-1/16	22.250	2.309	20.625	5.31	BX 156	15
11	28.000	3.005	25.000	6.17	BX 158	28

Specifications for Clamps

Clamp No.	HUB		Clamp No.	HUB		Clamp No.	HUB		
	API Designated Size (Inches)	Working Pressure (PSI)		API Designated Size (Inches)	Working Pressure (PSI)		API Designated Size (Inches)	Working Pressure (PSI)	
1	1-13/16	10,000	5	3-1/16	10,000	10	4-1/16	20,000	
	2-1/16	5,000		4-1/16	5,000		7-1/16	10,000	
2	1-13/16	15,000	6	2-9/16	20,000	11	9	10,000	
	2-1/16	10,000		3-1/16	15,000		11	5,000	
	2-9/16	5,000		4-1/16	10,000		13-5/8	3,000	
3	1-13/16	20,000	8	3-1/16	20,000	12	16-3/4	2,000	
	2-1/16	15,000		4-1/16	15,000		13	13-5/8	5,000
	2-1/16	10,000		7-1/16	10,000		14	16-3/4	3,000
	2-9/16	5,000		9	5,000		15	13-5/8	10,000
4	2-9/16	10,000	9	11	3,000	15	11	15,000	
	3-1/8	5,000		7-1/16	20,000				

SWIVEL JOINTS

Specifications

Windlass manufactures Swivel Joints which are metallic pipe fittings with integral ball-bearing swivels. Features include:

- ◆ Smooth rotation and movement without sacrificing strength and integrity of the steel
- ◆ Streamlined bore minimizes flow restrictions, turbulence and pressure drop
- ◆ Long-sweep Swivel Joints have extra-long radius elbows for better flow characteristics
- ◆ Manufactured specifically for high pressure applications
- ◆ Dual and tri-race ball bearing Swivel Joints are matched to load capacities & service conditions

Models	Color Code	Cold Working Pressure (PSI)	Material	End Connections	Sizes (Inches)							
					3/4	1	1 1/4	1 1/2	2	3	4	
Low Pressure Swivel Joints	Blue	1,000	Carbon Steel	NPT							✓	
				Beveled for welding							✓	
High-Pressure Swivel Joints	Silver	6,000	Alloy Steel	Female line pipe threads	✓	✓	✓	✓	✓	✓		
				figure 602 union	✓	✓	✓	✓	✓	✓		
Long Sweep Swivel Joints	Olive Green (Sour Gas)	7,500	Alloy Steel	figure 1002 union					✓	✓	✓	
	Olive Green (Sour Gas)	10,000	Alloy Steel	figure 1502 union					✓	✓	✓	
	Black	10,000	Alloy Steel	Female line pipe threads					✓	✓	✓	
				figure 1002 union					✓	✓	✓	
	Olive Green (Sour Gas)	15,000	Alloy Steel	figure 2202 union					✓	✓		
	Red	15,000	Alloy Steel	figure 1502 union					✓	✓	✓	
Light Blue	20,000	Alloy Steel	figure 2002 union					✓	✓			

- ◆ All ball races are either flame hardened, carburized & hardened or snap-in stainless steel
- ◆ All Swivel Joints are field repairable and easy to use. Repair kits are available
- ◆ Eight short radius Swivel Joint styles and configurations are available
- ◆ Threaded, integral wing union, beveled for welding or flanged end connections are available
- ◆ Sizes available 1" to 4" furnished with high nitrile packing and brass or stainless steel ring
- ◆ All joints are specially heat treated to achieve optimal hardness
- ◆ All materials meet ASTM and/or AISI standards
- ◆ 100% quality control and testing
- ◆ Available in stock at our distribution center in Houston
- ◆ Sour gas Swivel Joints are manufactured in accordance with the National Association of Corrosion Engineers (NACE) standard MR-01-75 & the American Petroleum Institute's (API) standard RP-14-E



HIGH PRESSURE SHORT RADIUS SWIVEL JOINTS

Available in sizes 3/4" through 3" for 6,000 PSI, non-shock cold working pressure. All sizes available in eight styles for 360° rotation in one, two or three planes. These Swivel Joints are recommended for hydraulic control lines, mud lines, rotary, line connections, BOP lines, test lines, water lines, offshore wellhead connections, cementing, circulating hoses and choke-kill lines.

Features:

- ◆ Smooth rotation and movement without sacrificing strength and integrity of the steel
- ◆ Streamlined bore minimizes flow restrictions, turbulence and pressure drop
- ◆ End connections are threaded or union ends
- ◆ All joints are specially heat treated to maintain optimal hardness and undergo strict quality control
- ◆ All material meets ASTM and/or AISI standards

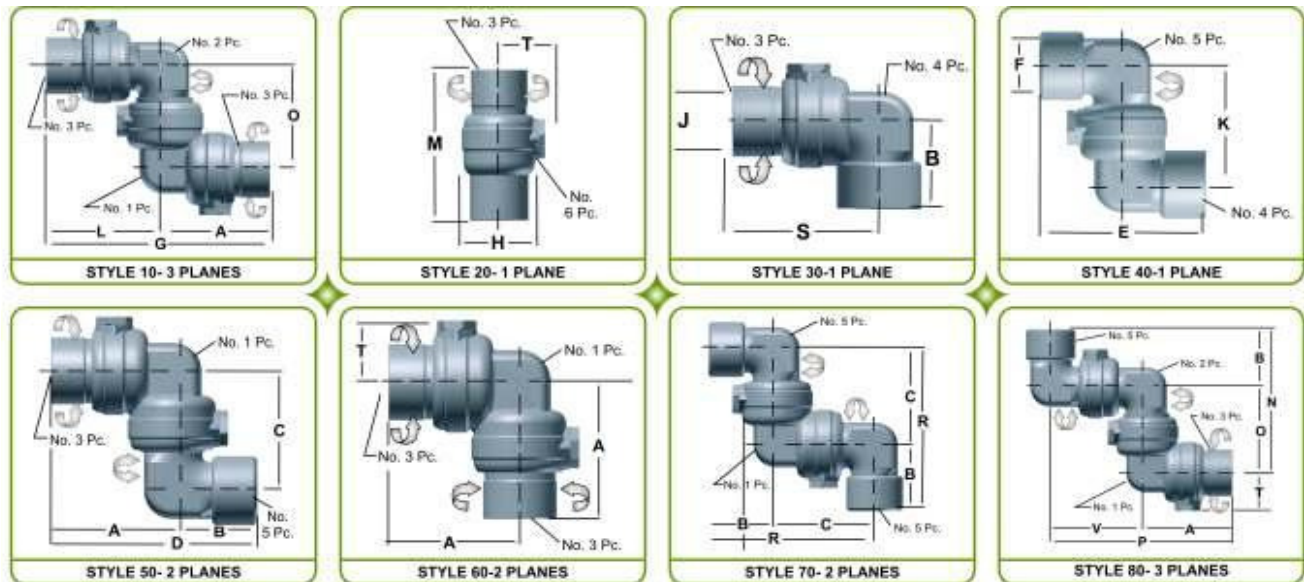

Size Chart

SIZE (Inches)	A	B	C	D	E	F	G	H	J	K	L	M	N	O	P	R	S	T	V
3/4-1	4-5/8	2-23/32	4-7/32	7-11/32	5-7/16	1-3/4	9-1/4	2-7/16	1-3/4	4-7/32	4-5/8	5-3/16	6-15/16	4-7/32	8-27/32	6-15/16	4-5/8	1-7/8	4-7/32
1-1/4/1-1/2	4-23/32	3-3/16	4-9/32	7-29/32	6-3/8	2-1/2	10-1/32	2-7/8	2-3/8	4-9/32	5-5/16	5-15/32	7-15/32	4-9/32	9-9/16	7-15/32	4-23/32	2-1/8	4-27/32
2	5-27/32	4-1/32	5-7/8	9-7/8	8-1/16	3-1/8	12-5/16	4-1/8	3-5/16	5-7/8	6-15/32	6-21/32	10-1/32	6	12-11/32	9-29/32	5-27/32	2-21/32	6-1/2
3	8-5/8	4-5/8	7-15/16	13-1/4	9-1/4	4-5/16	18-1/16	5-13/16	4-1/2	8-3/4	9-7/16	9-1/8	12-9/16	7-15/16	17-3/8	12-9/16	9-7/16	3-3/8	8-3/4

Note :- All dimensions are in inches.

EXTRA HIGH PRESSURE LONG SWEEP SWIVEL JOINTS

- ◆ Our tri-race code black swivels are available in 10,000 PSI working pressure with female line pipe thread and connections
- ◆ Our tri-race code red Swivel Joints are designed for the critical service conditions that exist in fracturing, cementing, acidizing and well testing. They are available in 2", 3" and 4" sizes with 15,000 PSI working pressure and 22,500 PSI test pressure. With 1502 union ends for fast, easy make-up

Feature:

- Long sweep joints have extra long radius elbows for better flow characteristics
- Manufactured specifically for high pressure applications
- All Swivel Joints are field repairable and easy to use. Repair kits are available
- Tri-race ball bearing Swivel Joints are matched to load capacities & service conditions
- All ball races are either flame hardened or snap-in stainless steel
- Available in both union and threaded ends

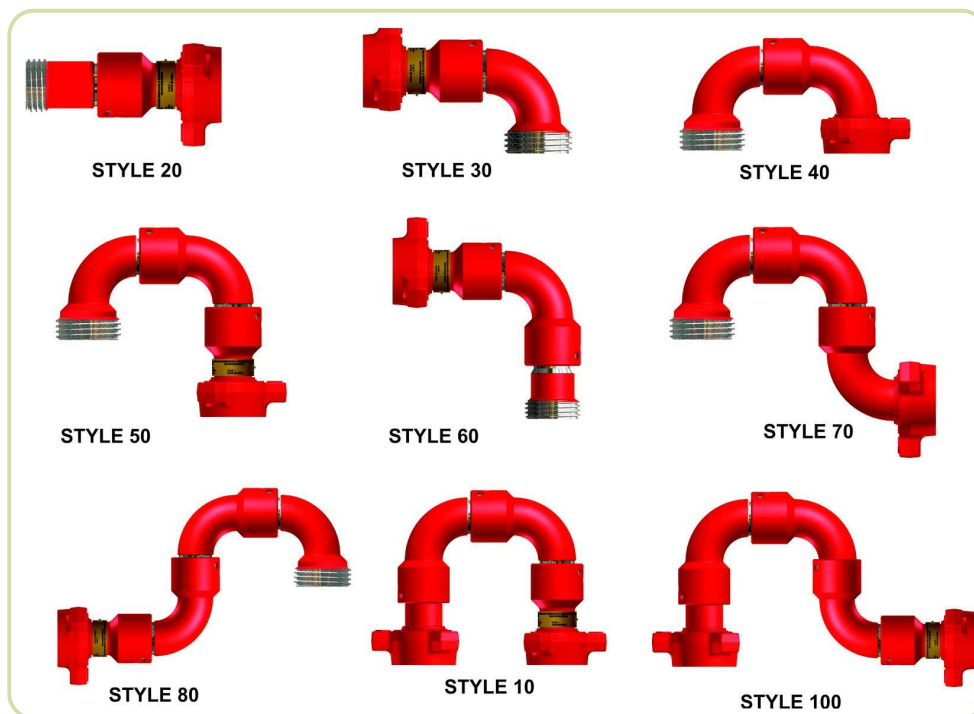

STYLE & TYPES

2" Union Ends

STYLE NO. 10 - Male x Female		STYLE NO. 10 - Male x Male		STYLE NO. 10 - Female x Female		STYLE NO. 20 - Male x Female
STYLE NO. 30 - Male x Female		STYLE NO. 40 - Male x Female		STYLE NO. 50 - Male x Female		STYLE NO. 50 - Male x Male
STYLE NO. 50 - Female x Female		STYLE NO. 60 - Male x Female		STYLE NO. 70 - Male x Female		STYLE NO. 80 - Male x Female
STYLE NO. 100 - Male x Female						

3" Union Ends

STYLE NO. 10 - Male x Female		STYLE NO. 10 - Male x Male		STYLE NO. 10 - Female x Female		STYLE NO. 30 - Male x Female
STYLE NO. 50 - Male x Female		STYLE NO. 50 - Female x Female		STYLE NO. 60 - Male x Female		STYLE NO. 80 - Male x Female

4" Union Ends, 1002

STYLE NO. 20 - Male x Female		STYLE NO. 30 - Male x Female		STYLE NO. 50 - Male x Female		STYLE NO. 10 - Male x Female
STYLE NO. 10 - Male x Male						

4" Union Ends, 1502

STYLE NO. 50 - Male x Female		STYLE NO. 60 - Male x Female		STYLE NO. 10 - Male x Female		STYLE NO. 10 - Male x Male
------------------------------	--	------------------------------	--	------------------------------	--	----------------------------

STEEL HOSE ASSEMBLIES

- ◆ Used in a variety of high pressure well service applications
- ◆ Utilize swivel joint & hammer union end connections for fast and secure make up & breakout operations
- ◆ Made to with stand cold working pressures up to 15,000 PSI for standard service and 10,000 PSI for sour service
- ◆ Windlass Steel Hoses Assemblies eliminate the need for exact alignment when installing to facilitate the routing of lines around fixed objects and simplify folding, transporting and storage of equipment
- ◆ Available in stock at our distribution center in Houston

Specifications

Size	Swivel Joint Style	Quantity of Wing Unions	Weight (LBS)
2" x 10'	50 & 10	1	147
2" x 12'	50 & 10	1	170
2" x 12'	(2) 50	2	179
2" x 12'	(2) 50	4	207
3" x 12'	(2) 50	4	454

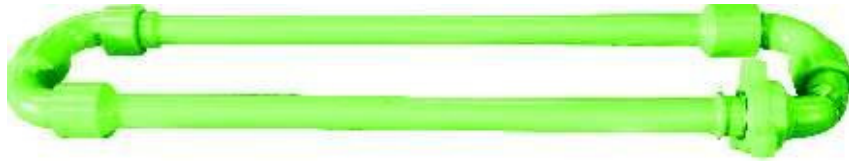

PUP JOINTS

Windlass manufactures Pup Joints with integral hammer lug union end connections. This enables faster, easier make-up and break-out of temporary flow lines.

- ◆ Integrally forged hammer lug union end connections eliminate welding or threading
- ◆ Lightest Pup Joint available for fast, easy handling
- ◆ Available in butt weld, integral, threaded (LPT & NPST)
- ◆ Sizes from 2" to 4". Integral Pup Joint available in lengths up to 12 feet while threaded / butt weld is available up to 20 feet
- ◆ Available in 6,000 to 20,000 PSI pressure rating
- ◆ All products manufactured from forged steel which meets ASTM and/or AISI standards
- ◆ Available in both standard and H2S service
- ◆ Available in stock at our distribution center in Houston

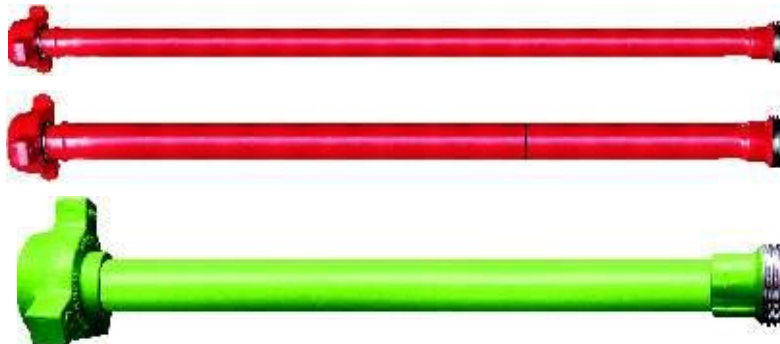

ADAPTERS & CROSSOVERS

Windlass Adapters and Crossovers are available in high quality forged construction with threaded, integral & welded hammer lug union end connection.

Reference Chart



Size (Inches)	Configuration	End Connection	CWP (PSI)	Weight (LBS)
2	MxM	1502	15,000	17
2	MxF	1502	15,000	22
2	FxF	1502	15,000	11
2x3	MxM	1502	15,000	38
2x3	MxF	1502	15,000	32
2x3	FxM	1502	15,000	31
2x3	FxF	1502	15,000	30
3	MxM	1502	15,000	41
3	FxF	1502	15,000	41

Note: Also available in other configurations on request.

FLANGES, TEES & CROSSES

Windlass manufactures Flow Line Products under API 6A and 16A. These include:

◆ Flanges

- Weld Neck Flange
- Adapter Flange
- Blind Flange
- Companion Flange



◆ Tees, Crosses, Blocks and Double Studded Adapter Flanges (DSAF)

These products are supplied per customer requirement of PSL level, material class and temperature class. They come with full material traceability documents







Specifications







Material Designation	Yield Strength 2% Offset Min.		Tensile Strength Min.		Elongation in 50mm Min.	Reduction of Area Min.
	MPa	PSI	MPa	PSI	%	%
36K	248	36,000	483	70,000	21	None Specified
45K	310	45,000	483	70,000	19	32
60K	414	60,000	586	85,000	18	35
75K	517	75,000	655	95,000	17	35

INTEGRAL FITTINGS

Windlass Integral Fitting is a high quality forged construction with wing union end connections and can be combined to suit virtually any installation. All Integral Fittings come with full material traceability. Available in stock at our distribution center in Houston.

Quick Reference Chart

Integral Fitting Sizes (Inches)	Hammer Union Figure No.	Long sweep Elbows		Block Elbows		
						
		FxM (LBS)	MxM (LBS)	FxM (LBS)	MxM (LBS)	FxF (LBS)
2	602	23	28	28	34	23
	1502	29	35	31	43	28
3	602	55	59	102	106	98
	1502	56	60	103	107	100
4	602	89	102	-	-	-
	1502	951	135	-	-	-

Integral Fitting Sizes (Inches)	Hammer Union Figure No.	Tees						Wyes
								
		FxFxF (LBS)	FxFxM (LBS)	MxFxF (LBS)	MxFxM (LBS)	MxMxF (LBS)	MxMxM (LBS)	MxFxF (LBS)
2	602	30	34	34	39	39	43	28
	1502	30	39	39	47	47	55	28
3	602	119	108	109	118	118	123	-
	1502	119	113	113	126	127	134	-

Dimensions

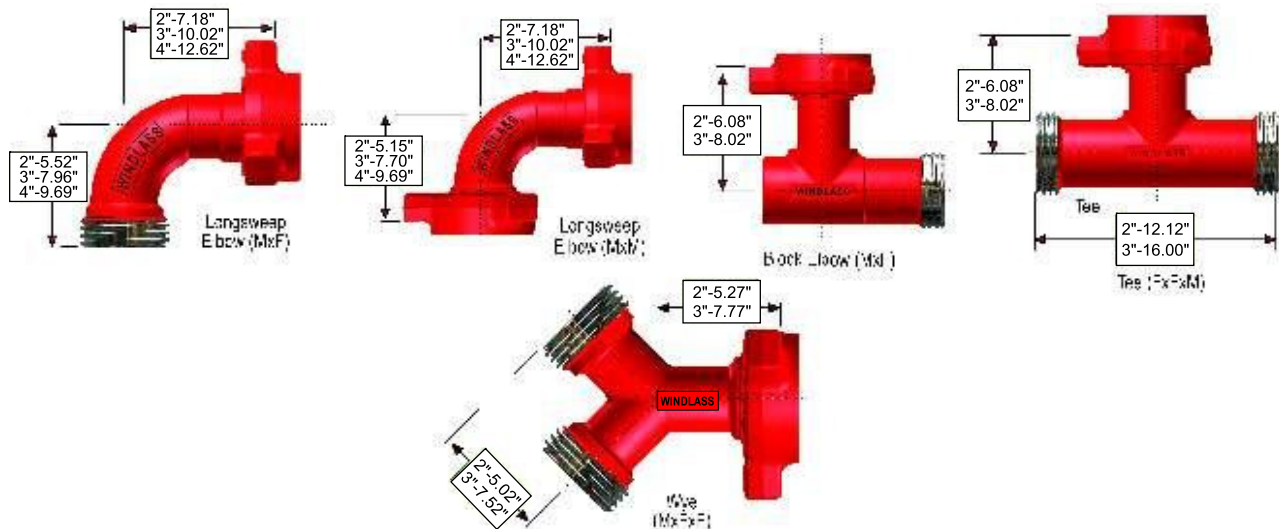

HYDRAULIC POWER UNITS



HYDRAULIC POWER UNITS

Electric or diesel powered units designed to provide maximum power output from a compact, rugged and reliable design.

- ◆ Reliable power to cussing, tubing tongs and other applications
- ◆ Available in standard or custom configurations
- ◆ Meet or exceed industry standards
- ◆ Expendable parts are chosen from the best recognized brands for easy availability regardless of location

ELECTRIC POWER UNITS

- ◆ Available in 50 / 60 Hz, 190 / 380 Volts, 220 / 440 Volts
- ◆ Equipped with electric motor, starter, hydraulic reservoir, heat exchanger, pump and other components mounted for easy transport and adjustment
- ◆ Centrally located lifting eye facilitates hoisting of unit to desired location

DIESEL POWER UNITS

- ◆ Available in standard or custom configurations
- ◆ Standard diesel or electric power options for recognized dependability and long, trouble-free service
- ◆ Features 3, 4 or 6 cylinder engines and large hydraulic oil reservoirs
- ◆ Each unit includes air or water-cooled engines and storage basket for hoses



MANIFOLDS

Windlass offers a complete range of Manifold systems for drilling and production applications.

- ◆ Incorporate gate valves, check valves, chokes and actuators depending on the application and customer requirement
- ◆ Mounted for ease of transport and height adjustment
- ◆ Meet or exceed API 6A and 16C
- ◆ Remote control operation available
- ◆ Various control panel options are available to control kick and blowout
- ◆ Working pressures:
2M, 3M, 5M, 10M, 15M (PSI)
- ◆ Main nominal sizes:
2-1/16, 2-9/16, 3-1/8, 3-1/16, 4- 1/16 (Inches)
- ◆ Types of Manifolds : Choke & Kill, Cement & Standpipe



CUSTOM PRODUCT DEVELOPMENT & CONTRACT MANUFACTURING

Put your product development on the fast track by leveraging Windlass' experience and infrastructure. Tap into our in-house capabilities and take your idea from concept, to design, to prototype, to final product at a speed you never thought possible.

Already have a product and need to improve quality and reduce cost? Windlass will put our expertise in manufacturing, fabrication and supply chain management to work for you. We can use our capability in forging, casting and machining to achieve cost reductions while improving quality and delivery. Windlass is ISO 9001:2008 and API certified with a network of reliable high quality suppliers who can meet almost any requirement of your company.

With offices in Houston, Windlass provides significant pre-sales and post-sales support, forming strong relationships with our customers. We build lasting partnerships with OEMs, not competitive relationships. Our efforts are focused squarely on helping OEMs succeed in their own marketplace.

Windlass handles all your information with uncompromised confidentiality and security. We understand the value of intellectual property and its importance to our customers, and do everything to protect it.

Do business with us and you will immediately recognize our competitive edge and high level of service. This reputation comes from the combination of advanced technologies used in equipment and quality control, processes and procedures which address improved manufacturing and cost effectiveness, and open communication with our customers.

Advanced Technology, Proven Processes, Complete Communication, Uncompromising Security. This is why we can offer the lowest total manufacturing cost and best control of your production requirements.





Contact Information :

USA

WINDLASS ENGINEERS & SERVICES, INC.
 1420 North Post Oak Road
 Houston, TX 77055
 sales@windlassoilequipment.com
 U.S./Canada Toll Free : (877) 918-2025
 Phone : +1 (713) 680-3338
 Fax : +1 (713) 680-3328
 www.windlassengineers.com



INDIA

WINDLASS ENGINEERS & SERVICES PVT. LTD.
 VPO - Balawala, Haridwar Road
 Dehradun - 248161
 Uttarakhand, India
 sales@windlassengineers.com
 Phone : +91-135-2686470, 2686623, 2686624
 Fax : +91-135-2686622
 www.windlassengineers.com